

SPECIFICATION

JCB POTHOLE PRO
HYDRADIG



POTHOLE PRO

Area/day: 250m² Pothole repair: 8 minutes Repair/m²: £29.28



CUT. CROP. CLEAN.

The new JCB Pothole Pro is a unique 3 in 1 solution specifically designed to sort out any pothole repair or large reinstatement operations, efficiently, economically and permanently. Because it comes with 3 dedicated attachments to cut, crop and clean, there's no need for additional specialist equipment or extra manpower, saving you both time and money. And with a typical pothole repaired in 8 minutes, why compromise on a quick fix that won't last, when you can have quick and permanent? In fact, all you need to add, is the tar.

UNCOMPROMISING POTHOLE REPAIR.

Designed to work safely and efficiently in congested urban areas, the Pothole Pro prepares a pothole safely, in just 8 minutes - ready for reinstatement.



CUT FROM THE CAB.

From the cab, you can easily adjust the 600mm planer, with hydraulic depth and tilt control to improve safety and maximise performance.



CROP FOR REPAIRS THAT LAST.

Maximise the life of your pothole repair with the dedicated cropping tool, which provides a uniform hole profile that lasts.



CLEAN WITH ONE MACHINE.

The 1200mm wide sweeper collector with dust suppression, enables you to prepare your pothole in a matter of minutes.



LOWEST COST PERMANENT REPAIR.

You can count on the JCB Pothole Pro to sort out any pothole repair or large reinstatement operations, efficiently, economically and permanently.

STATIC DIMENSIONS

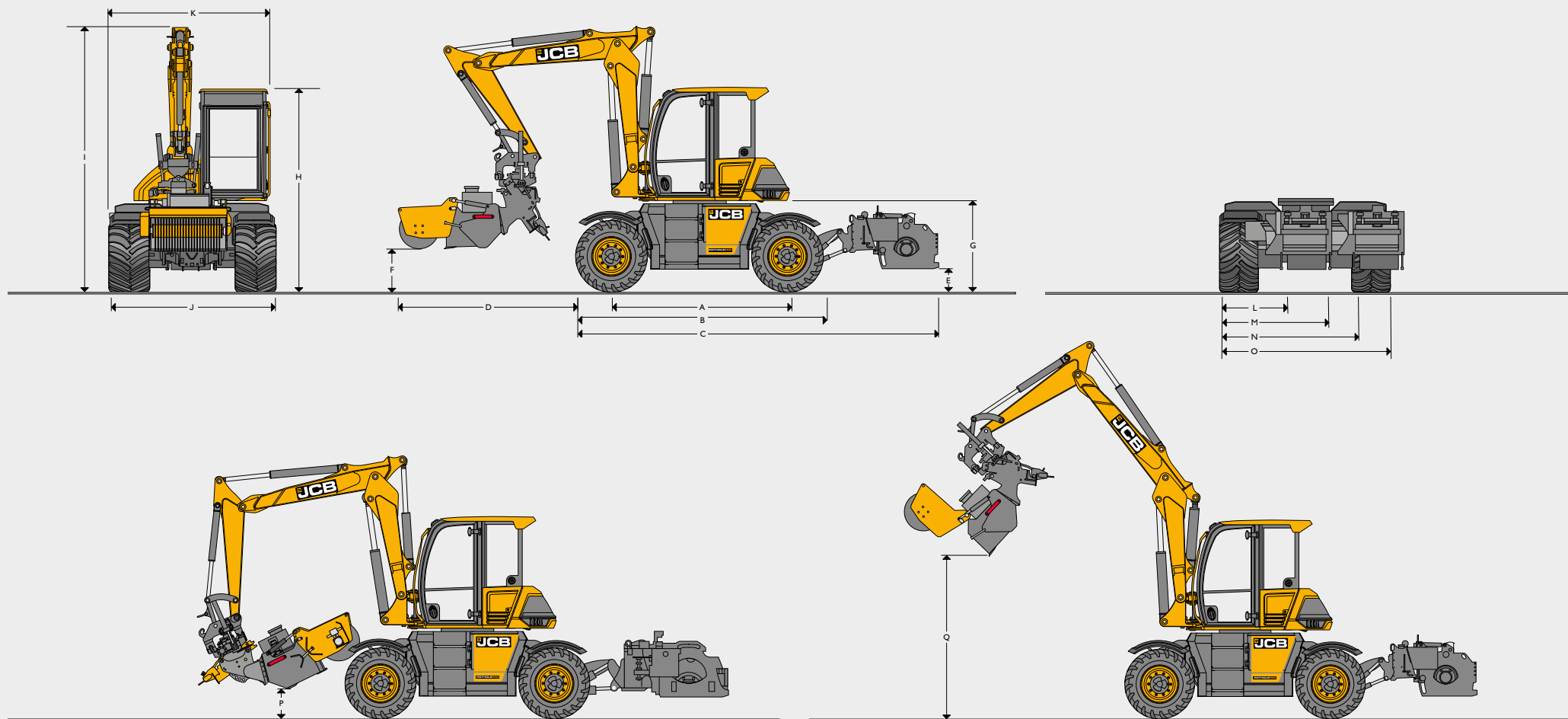

A	Wheel base	mm	2650
B	Length over tyres	mm	3750
C	Length over tyres and planer	mm	5490
D	Front transport length	mm	2275
E	Planer transport height	mm	350
F	Sweeper transport height	mm	463
G	Slew height	mm	1375
H	Cab height	mm	3040
I	Transport height	mm	3980

J	Width over tyres	mm	2500
	Width over tyres and cab	mm	2470
L	Planer max right off set	mm	970
M	Planer max right offset and cut	mm	1570
N	Planer max left off set	mm	2000
O	Planer max left offset and cut	mm	2600
P	Ground clearance of sweeper	mm	463
Q	Max dump @40 degree bucket tip	mm	2900

STATIC DIMENSIONS

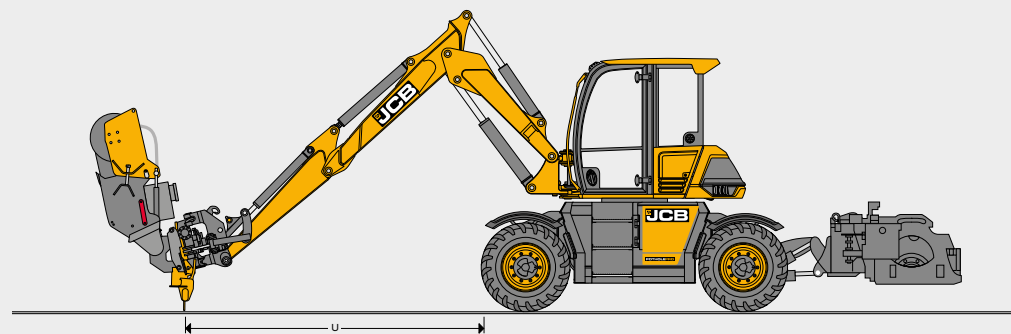
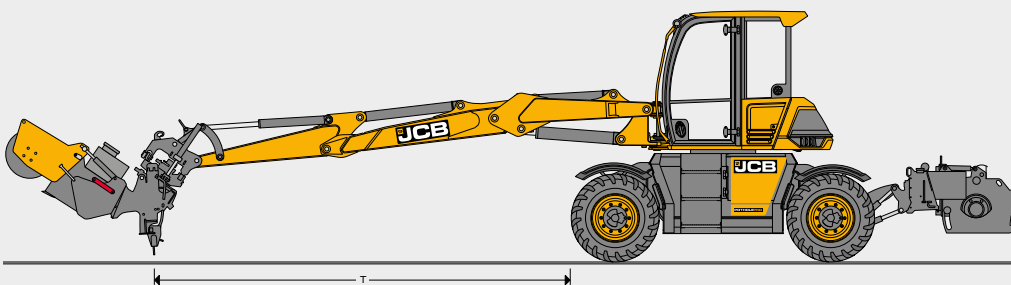
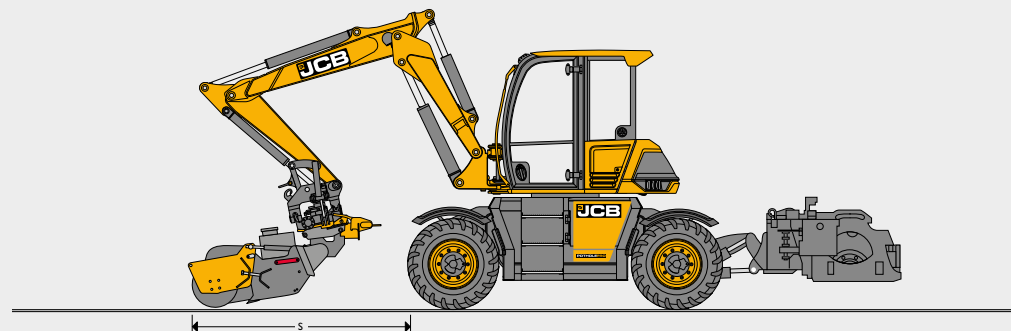
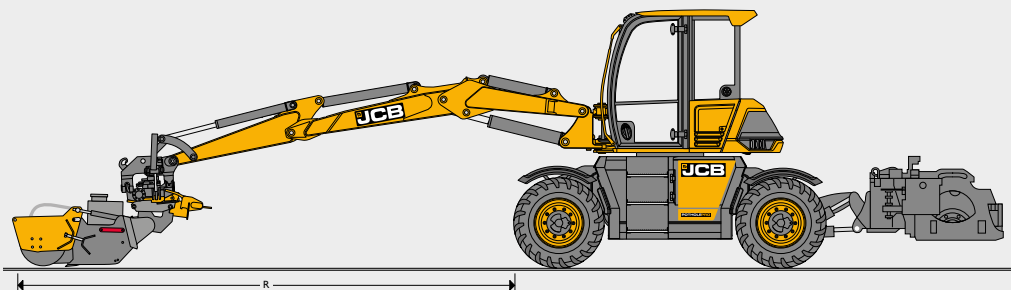

R	Max working reach with sweeper	mm	6637
S	Min working reach with sweeper	mm	3029
T	Max reach with hammer	mm	5136
U	Min cropping distance	mm	3725
V	Max ground length planing	mm	5490
W	Sweeper position when planing	mm	7480
	Max over hang with planer	mm	1740
	Front axle / rear axle		Oscillating steering axle / rigid steering axle
	Axles load capacity	tonnes	14
	Axles load oscillation	degrees	+/- 8
	Transmission		Hydrostatic drive via piston motor and stepless transmission

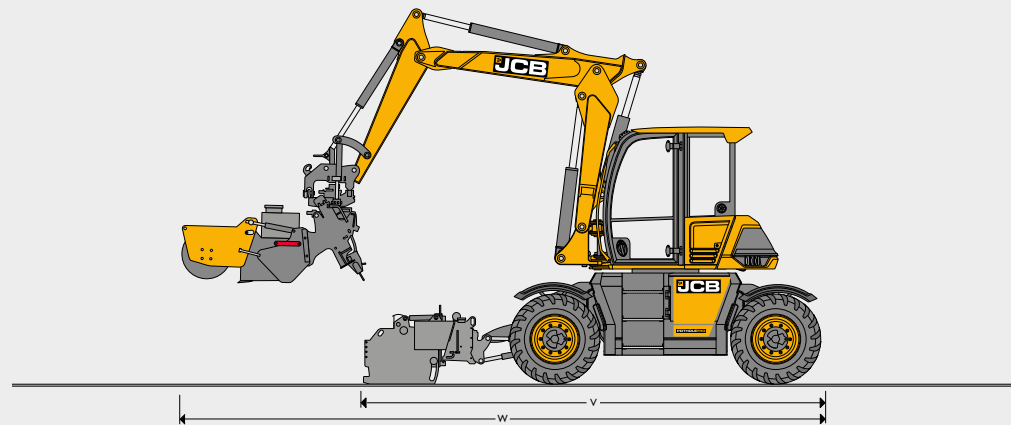

ENGINE	
Model	JCB EcoMAX 448 EU Stage V EPA compliant
Type	4-stroke, 4-cylinder in-line, common rail, direct injection, turbocharged and intercooled diesel
Rated power (ISO 14396)	81 kW (109 hp) @ 2200 rpm
Gross torque (ISO 14396)	516Nm @ 1450 rpm
Piston displacement	4.8 litres
Air filtration	Dry element with secondary safety element and in-cab warning sensor
Starting system	12 volt
Batteries	12 volt
Alternator	12 volt, 170 ampere

MAIN HYDRAULIC SYSTEM	
System	Electronically controlled system using two variable displacement piston pumps plus twin gear pumps for steering, brakes and cooling
Services pump	72cc variable displacement axial piston pump
Flow rate @ 2200rpm	158.4 l/min
Excavator main relief pressure	280 bar
Transmission pump	85cc variable displacement axial piston pump in a closed loop hydrostatic drive system independent from working hydraulics
Flow rate @ 2200rpm	187 l/min
Transmission absolute pressure	525 bar
Upper high flow auxiliary	
High flow auxiliary pressure	210 bar
High flow auxiliary max. flow	120 l/min
Upper low flow auxiliary	
Low flow auxiliary pressure	210 bar
Low flow auxiliary max. flow	60 l/min
Second low flow auxiliary pressure	210 bar
Second low flow auxiliary max. flow	60 l/min
Free line return	2 bar
Case drain line	0.5 bar
Lower high flow auxiliary	
High flow auxiliary pressure	280 bar
High flow auxiliary max. flow	150 l/min
Free line return	2 bar
Case drain line	0.5 bar
QRC on all hose connections	
Hydraulic cylinders	Hardened, chromed piston rods with end damping on boom raise and dipper in
Filtration	
In tank	125 micron suction strainer
Main return line	10 micron return line filter

SLEW SYSTEM	
Slew motor	Axial piston type
Slew brake	Hydraulic braking plus automatic spring applied disc type parking brake
Slew torque	27.0 kNm
Slew speed	8.9 rpm
Slew gear	11 tooth pinion / 84 tooth ring

TYRES	
Type	Floatation
Dimensions	600 x 40 - 22.5
Inflation pressure	6 Bar (87 Psi)
Ply/load rating	18

TURNING RADIUS	
To outside of tyre	4850
To outer edge of planer	5240

TRAVEL SPEED	
Max. roading speed	40 kp/h
Drawbar pull	45 kNm
Steering	Fully hydraulic system with 4-wheel steer, 2-wheel steer and crab steer

BRAKES	
Brakes	All hydraulic dual circuit brake system with positive brake back off
Parking brake	Dedicated park brake disc on rear axle input
Gradability	26.6° / 50% maximum continuous, 35° (up and down) or 17° (across)

SERVICE CAPACITIES		
Fuel tank	litres	157
Engine coolant	litres	28
Engine oil	litres	14
Hydraulic system	litres	190
Hydraulic tank	litres	130
Transmission (dropbox)	litres	1
Axle differentials (each)	litres	Front = 18, rear = 14
Axle hubs (each)	litres	2
DEF fluid capacity	litres	19

OPERATING WEIGHT		
Machine equipped with all attachments and 75kg operator, 154kg fuel and floatation tyres	kg	13350

ATTACHMENTS**Cropping Tool**

HM012T hammer

400mm as standard

Mounted on the 360 Multitool

Planer

Simex 600mm planer

Mounted on a skid steer compatible hitch

Dust suppression

Tilt 8 degrees either way

Max cutting depth 170mm

Modes: floating or powered tilt

Sideshift: 1.3m traverse to the kerb side

QRC on all hydraulic connections

Water drain down point included

External water filter with easy clean filter

Standard 14-way skid steer electrical connector

Sweeper Collector

Hydraulic powered brush 625mm diameter

1200mm width

Hydraulic opening hood for bucket / collector mode

0.3m cube shovel capacity

Dust suppression through twin outlet water suppression ports

QRC on all hydraulic connections

Drain down point included

External water filter with easy clean filter

Quick connect cable for water pump

POTHOLE PRO STANDARD FEATURES

Single pivot chassis

ENGINE

JCB EcoMAX 448 EU Stage V EPA compliant

4.8 litre, 81kW @ 2200rpm, 516Nm @ 1450rpm

Start pre heat (Grid Heater)

One touch idle

Auto idle function

DOC and SCRf system

2x 12v 1000CCA Batteries

Fuel filter with water separator

Electronic engine control

Engine auto stop

Fuel cooler

SAFETY

Battery isolator

Key

JCB 2GO

Lockable fuel cap

Hydraulic cap lock

Full LED 2 x dipper 2 x boom 2 x cab front 2 x cab rear 2 x cab side

Rear camera

Fire extinguisher

ROPS and FOPS cab

Reverse alarm

Rear fog lights

Amber beacon

Full road light and mirrors

CONTROLS AND FEATURES

Side exit exhaust

40 kph transmission

Reverse steering system

Hogarth 46 hydraulic oil

4 wheel fenders

Full belly guards

JCB LiveLink

Rear trailer electrics

Smooth ride system

Cruise control

5 tonne lifting link

Cesar data tag

EH proportional control

Two wheel, four wheel and crab steering options

ATTACHMENTS

4 line tilt - rotator (Steelwrist)

S45 to skid steer dipper hitch

HM120 hammer with 600 mm blade

600mm sideshifting planer

SC120 sweeper collector shovel

CAB

Sound insulated and 4 shock mounted cab

Deluxe high back fabric air suspension seat with heated base

Height adjustable arms

Sliding window

Immobiliser

7" colour display

Front up and over window with removable lower section

Dual front wiper

Media port

Rain visor

Number plate prov

Radio kit

Locking park brake

3" Hi Vis seat belt

Climate control

Momentary park brake & locking brake pedal

Travel speed indicator











Highway and site mode

Enhanced tilt-rotator controls

Rear wash wipe

Internal storage container

LIFT CAPACITIES: 1.65M WITHOUT ATTACHMENTS TAB

Reach	3m		4m		5m		6m		Capacity at Max Reach		
											
Load Point Ht.	kg	kg	kg	kg	kg	kg	kg	kg	kg	kg	mm
4.5m	1827*	1827*	2105*	2105*	1767*	1422	-	-	1516*	1030	5964
3.0m	-	-	2566*	1886	1954*	1358	1512*	1018	1384*	878	6518
1.5m	-	-	2913*	1725	2147*	1276	1625*	983	1395*	845	6632
0m	-	-	2691*	1688	2024*	1242	1500*	971	1230*	909	6339
-1.0m	2789*	2789*	2250*	1719	1695*	1256	-	-	1042*	1042*	5887

 Lift capacity front and rear.

 Lift capacity full circle.

- Notes:**
1. For lifting capacity including bucket, subtract total weight of bucket or bucket and quickhitch from above values.
 2. Lifting capacities are based on ISO 10567, that is: 75% of minimum tipping load or 87% of hydraulic lift capacity, whichever is the less. Lifting capacities marked* are based on hydraulic capacity.
 3. Lift capacities assume that the machine is on firm, level ground.
 4. Lift capacities may be limited by local regulations. Please refer to your dealer.



ONE COMPANY, OVER 300 MACHINES.

Your nearest JCB dealer

Pothole Pro

Area/day: 250m² Pothole repair: 8 minutes Repair/m²: £29.28

JCB Sales Limited, Rokester, Staffordshire, United Kingdom ST14 5JP

Tel: +44 (0)1889 590312 Email: salesinfo@jcb.com

Download the very latest information on this product range at: www.jcb.com

©2021 JCB Sales. All rights reserved. No part of this publication may be reproduced, stored in a retrieval system, or transmitted in any form or by any other means, electronic, mechanical, photocopying or otherwise, without prior permission from JCB Sales. All references in this publication to operating weights, sizes, capacities and other performance measurements are provided for guidance only and may vary dependant upon the exact specification of machine. They should not therefore be relied upon in relation to suitability for a particular application. Guidance and advice should always be sought from your JCB Dealer. JCB reserves the right to change specifications without notice. Illustrations and specifications shown may include optional equipment and accessories. All images are correct at time of print. The JCB logo is a registered trademark of J.C. Bamford Excavators Ltd.

